

NPN Silicon AF Transistor Array

- Precision matched transistor pair: $\Delta I_C \leq 10\%$
- For current mirror applications
- Low collector-emitter saturation voltage
- Two (galvanic) internal isolated Transistors
- Complementary type: BCM856S
- BCM846S: For orientation in reel see package information below
- Pb-free (RoHS compliant) package
- Qualified according AEC Q101

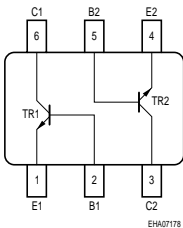

Type	Marking	Pin Configuration					Package
		1=E1	2=B1	3=C2	4=E2	5=B2	
BCM846S	1Ms						SOT363

Maximum Ratings

Parameter	Symbol	Value	Unit
Collector-emitter voltage	V_{CEO}	65	V
Collector-emitter voltage	V_{CES}	80	
Collector-base voltage	V_{CBO}	80	
Emitter-base voltage	V_{EBO}	6	
Collector current	I_C	100	mA
Peak collector current, $t_p \leq 10$ ms	I_{CM}	200	
Total power dissipation- $T_S = 115$ °C	P_{tot}	250	mW
Junction temperature	T_j	150	°C
Storage temperature	T_{stg}	-65 ... 150	

Thermal Resistance

Parameter	Symbol	Value	Unit
Junction - soldering point ¹⁾	R_{thJS}	140	K/W

Electrical Characteristics at $T_A = 25^\circ\text{C}$, unless otherwise specified

Parameter	Symbol	Values			Unit
		min.	typ.	max.	

DC Characteristics

Collector-emitter breakdown voltage $I_C = 10 \text{ mA}, I_B = 0 \text{ A}$	$V_{(BR)CEO}$	65	-	-	V
Collector-base breakdown voltage $I_C = 10 \mu\text{A}, I_E = 0 \text{ A}$	$V_{(BR)CBO}$	80	-	-	
Collector-emitter breakdown voltage $I_C = 10 \mu\text{A}, V_{BE} = 0 \text{ A}$	$V_{(BR)CES}$	80	-	-	
Emitter-base breakdown voltage $I_E = 10 \mu\text{A}, I_C = 0 \text{ A}$	$V_{(BR)EBO}$	6	-	-	
Collector-base cutoff current $V_{CB} = 30 \text{ V}, I_E = 0 \text{ A}$ $V_{CB} = 30 \text{ V}, I_E = 0 \text{ A}, T_A = 150^\circ\text{C}$	I_{CBO}	-	-	0.015 5	μA
DC current gain ⁻²⁾ $I_C = 10 \mu\text{A}, V_{CE} = 5 \text{ V}$ $I_C = 2 \text{ mA}, V_{CE} = 5 \text{ V}$	h_{FE}	- 200	250 290	- 450	-
Collector-emitter saturation voltage ²⁾ $I_C = 10 \text{ mA}, I_B = 0.5 \text{ mA}$ $I_C = 100 \text{ mA}, I_B = 5 \text{ mA}$	V_{CEsat}	- -	90 200	300 650	mV
Base emitter saturation voltage ²⁾ $I_C = 10 \text{ mA}, I_B = 0.5 \text{ mA}$ $I_C = 100 \text{ mA}, I_B = 5 \text{ mA}$	V_{BEsat}	- -	700 900	- -	
Base-emitter voltage ⁻²⁾ $I_C = 2 \text{ mA}, V_{CE} = 5 \text{ V}$ $I_C = 10 \text{ mA}, V_{CE} = 5 \text{ V}$	$V_{BE(ON)}$	580 -	660 -	700 770	
Matching $I_B = 1 \mu\text{A}, V_{CE1} = V_{CE2} = 1.0\text{V}$ $I_B = 100 \mu\text{A}, V_{CE1} = V_{CE2} = 1.0\text{V}$	ΔI_C	-10 -10	- -	10 10	%

¹⁾For calculation of R_{thJA} please refer to Application Note AN077 (Thermal Resistance Calculation)

²⁾Puls test: $t < 300\mu\text{s}; D < 2\%$

Electrical Characteristics at $T_A = 25^\circ\text{C}$, unless otherwise specified

Parameter	Symbol	Values			Unit
		min.	typ.	max.	
AC Characteristics					
Transition frequency $I_C = 20\text{ mA}, V_{CE} = 5\text{ V}, f = 100\text{ MHz}$	f_T	-	250	-	MHz
Collector-base capacitance $V_{CB} = 10\text{ V}, f = 1\text{ MHz}$	C_{cb}	-	0.95	-	pF
Emitter-base capacitance $V_{EB} = 0.5\text{ V}, f = 1\text{ MHz}$	C_{eb}	-	9	-	
Short-circuit input impedance $I_C = 2\text{ mA}, V_{CE} = 5\text{ V}, f = 1\text{ kHz}$	h_{11e}	-	4.5	-	$k\Omega$
Open-circuit reverse voltage transf. ratio $I_C = 2\text{ mA}, V_{CE} = 5\text{ V}, f = 1\text{ kHz}$	h_{12e}	-	2	-	10^{-4}
Short-circuit forward current transf. ratio $I_C = 2\text{ mA}, V_{CE} = 5\text{ V}, f = 1\text{ kHz}$	h_{21e}	-	330	-	-
Open-circuit output admittance $I_C = 2\text{ mA}, V_{CE} = 5\text{ V}, f = 1\text{ kHz}$	h_{22e}	-	30	-	μS
Noise figure $I_C = 200\text{ }\mu\text{A}, V_{CE} = 5\text{ V}, f = 1\text{ kHz},$ $\Delta f = 200\text{ Hz}, R_S = 2\text{ k}\Omega$	F	-	-	10	dB

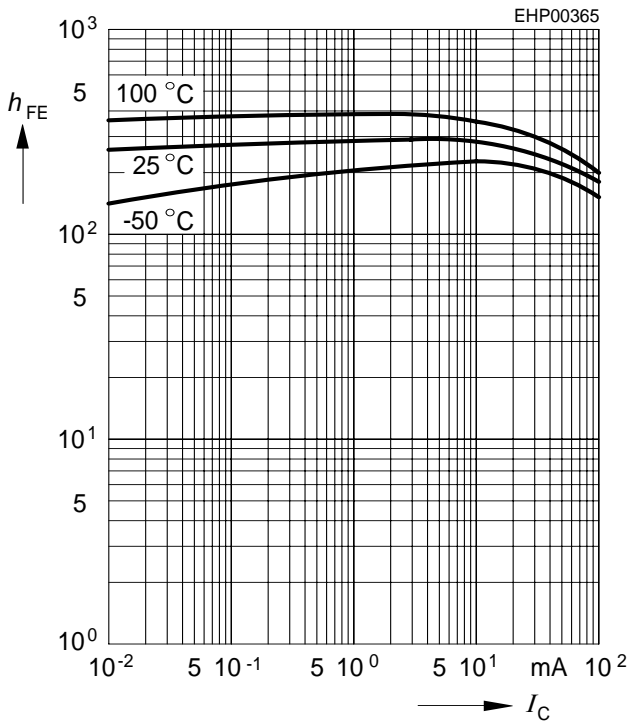
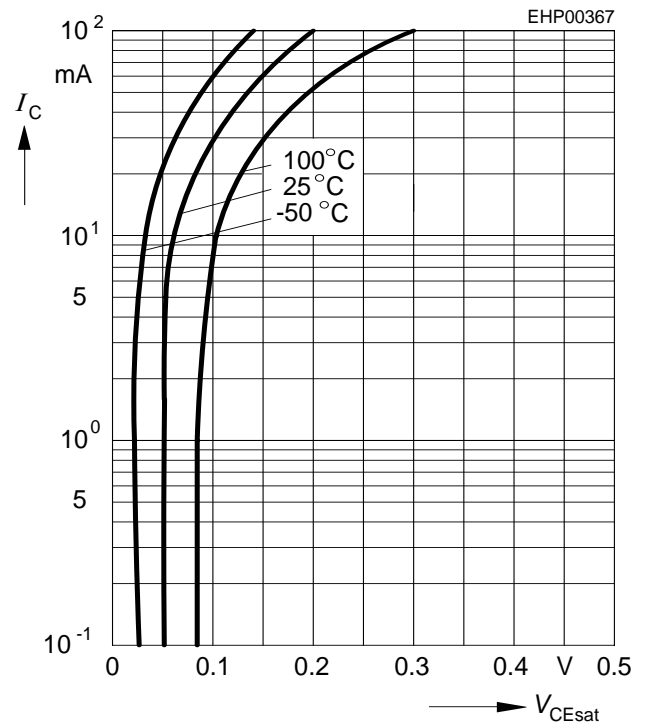
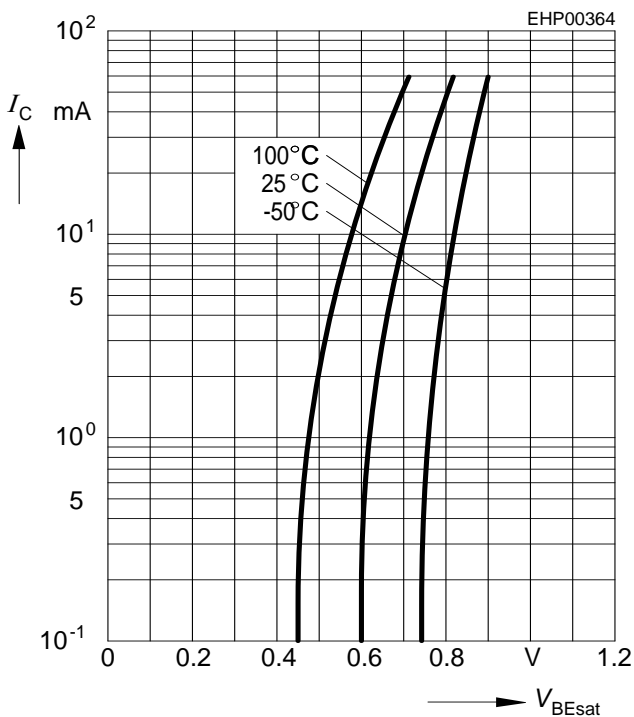
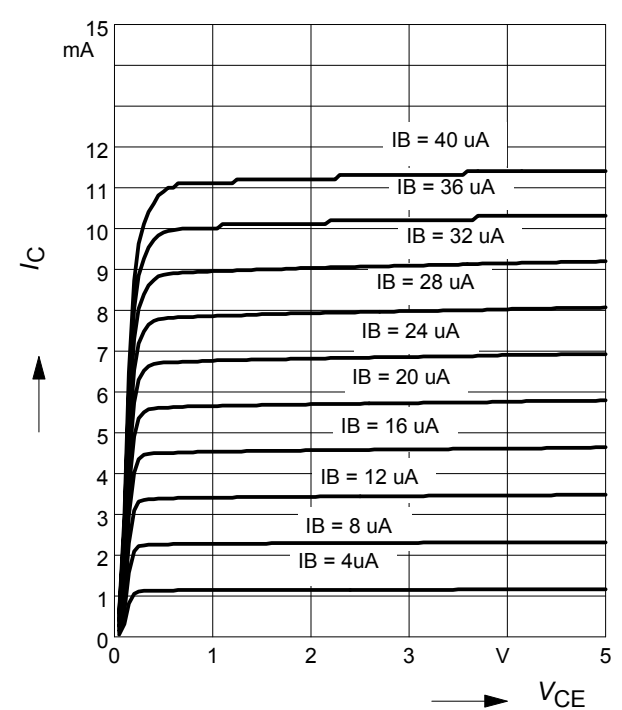
DC current gain $h_{FE} = f(I_C)$
 $V_{CE} = 5V$

Collector-emitter saturation voltage
 $I_C = f(V_{CEsat}), h_{FE} = 20$

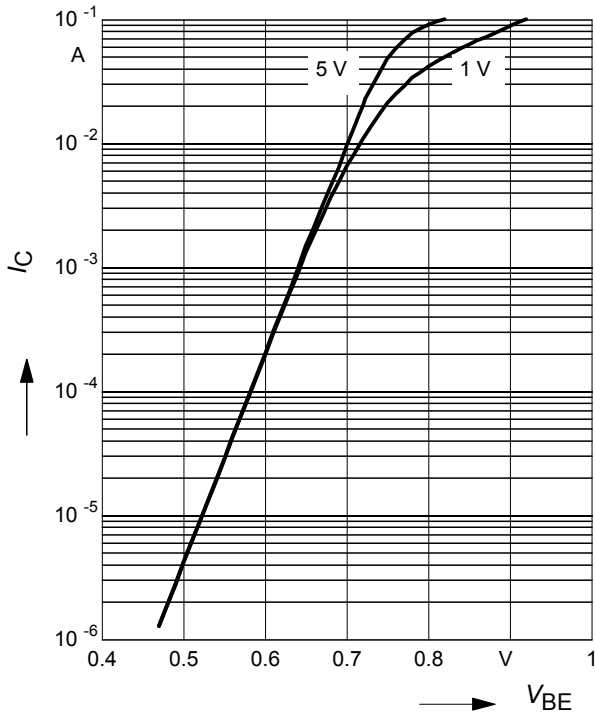
Base-emitter saturation voltage
 $I_C = f(V_{BEsat}), h_{FE} = 20$

Output characteristics $I_C = f(V_{CE})$,
 $I_B = \text{parameter}$

Collector current $I_C = f(V_{BE})$

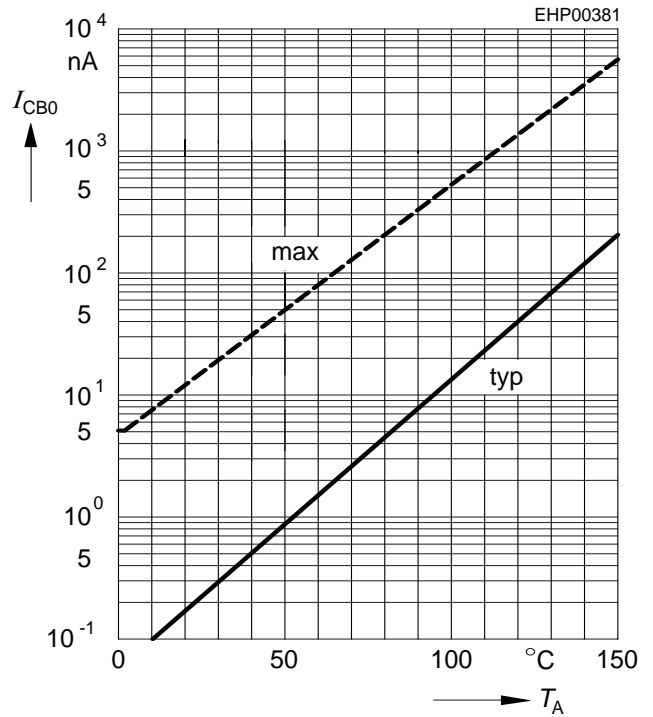

Collector cutoff current $I_{CBO} = f(T_A)$

$V_{CBO} = 30\text{ V}$



Transition frequency $f_T = f(I_C)$

$V_{CE} = \text{parameter in V, } f = 2\text{ GHz}$

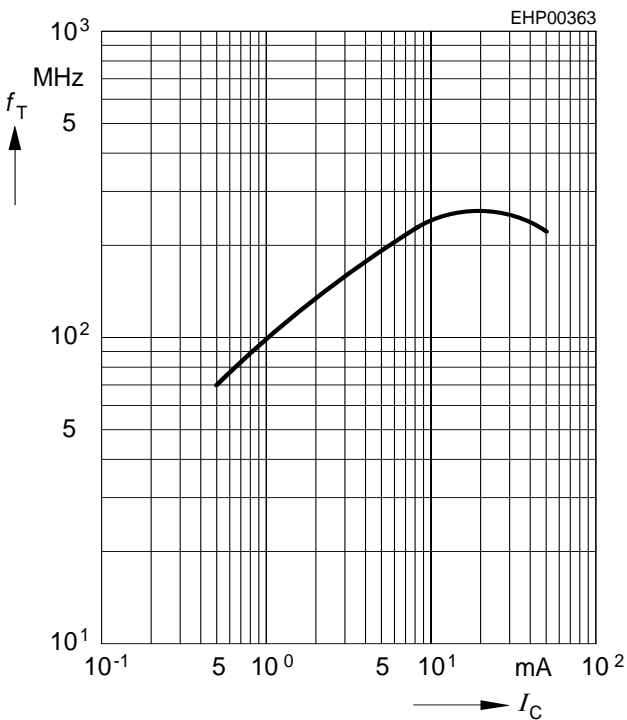

Collector-base capacitance $C_{cb} = f(V_{CB})$

Emitter-base capacitance $C_{eb} = f(V_{EB})$

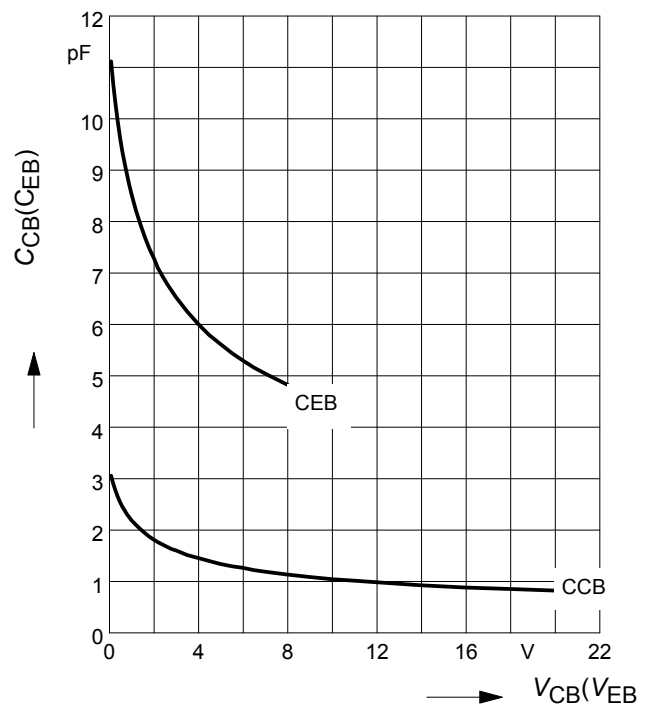

Total power dissipation $P_{tot} = f(T_S)$

Permissible Pulse Load $R_{thJS} = f(t_p)$

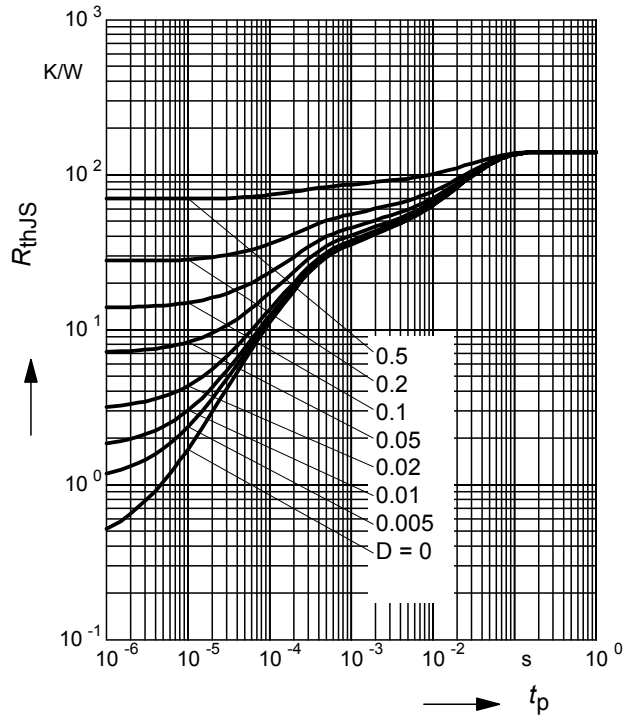
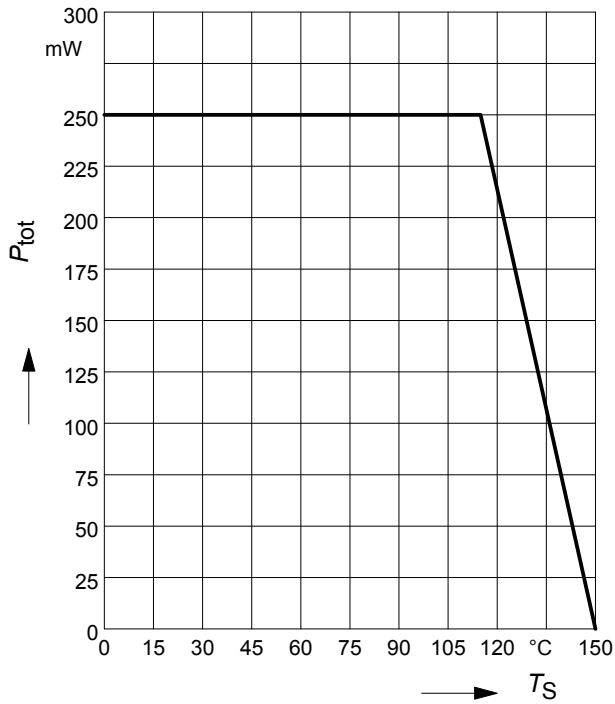

Permissible Pulse Load

$P_{totmax}/P_{totDC} = f(t_p)$

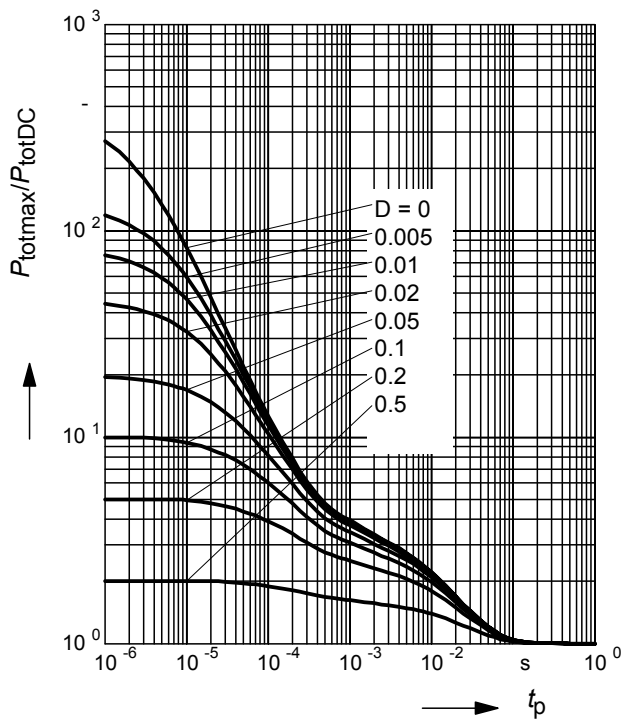

Definition of matching

$$\Delta I_C = (I_{C2} - I_{C1}) / I_{C1}$$

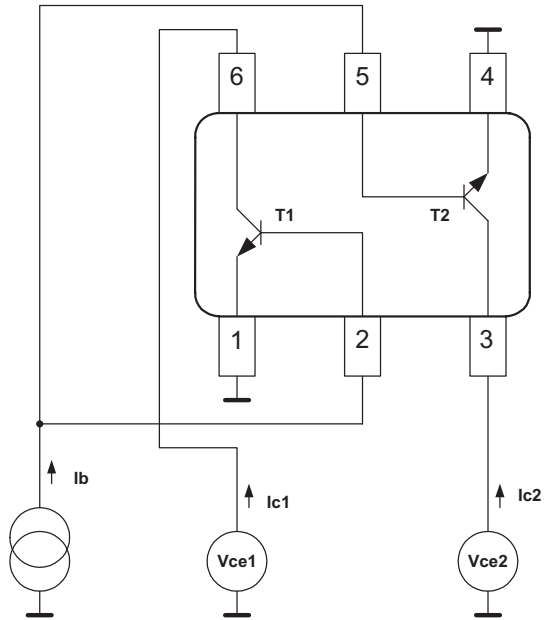

Package Outline

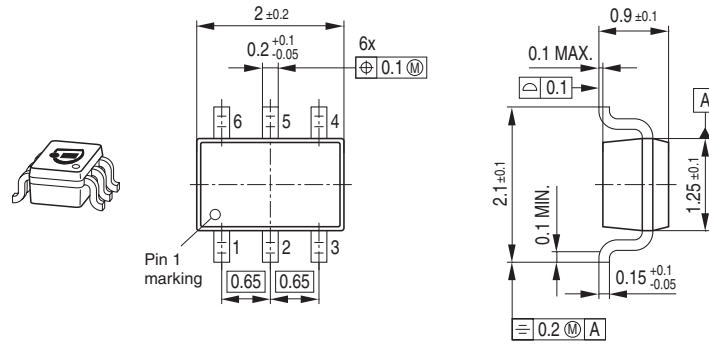

Foot Print

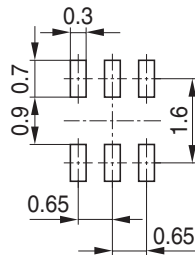

Marking Layout (Example)

Small variations in positioning of Date code, Type code and Manufacture are possible.

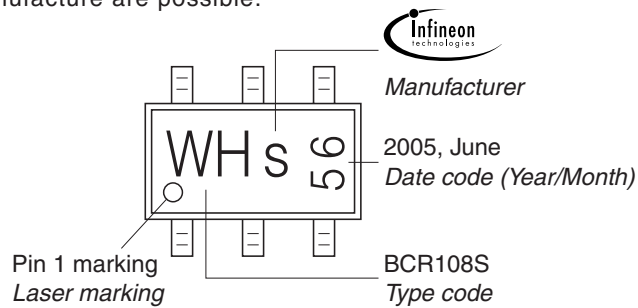

Standard Packing

Reel \varnothing 180 mm = 3.000 Pieces/Reel
 Reel \varnothing 330 mm = 10.000 Pieces/Reel

For symmetric types no defined Pin 1 orientation in reel.

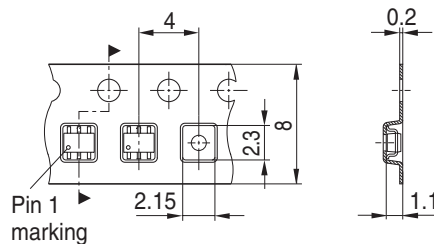

Edition 2009-11-16

**Published by
Infineon Technologies AG
81726 Munich, Germany**

**© 2009 Infineon Technologies AG
All Rights Reserved.**

Legal Disclaimer

The information given in this document shall in no event be regarded as a guarantee of conditions or characteristics. With respect to any examples or hints given herein, any typical values stated herein and/or any information regarding the application of the device, Infineon Technologies hereby disclaims any and all warranties and liabilities of any kind, including without limitation, warranties of non-infringement of intellectual property rights of any third party.

Information

For further information on technology, delivery terms and conditions and prices, please contact the nearest Infineon Technologies Office (www.infineon.com).

Warnings

Due to technical requirements, components may contain dangerous substances. For information on the types in question, please contact the nearest Infineon Technologies Office.

Infineon Technologies components may be used in life-support devices or systems only with the express written approval of Infineon Technologies, if a failure of such components can reasonably be expected to cause the failure of that life-support device or system or to affect the safety or effectiveness of that device or system. Life support devices or systems are intended to be implanted in the human body or to support and/or maintain and sustain and/or protect human life. If they fail, it is reasonable to assume that the health of the user or other persons may be endangered.

单击下面可查看定价，库存，交付和生命周期等信息

[>>Infineon Technologies\(英飞凌\)](#)

[>>点击查看相关商品](#)